

SP-C1, DP-D1

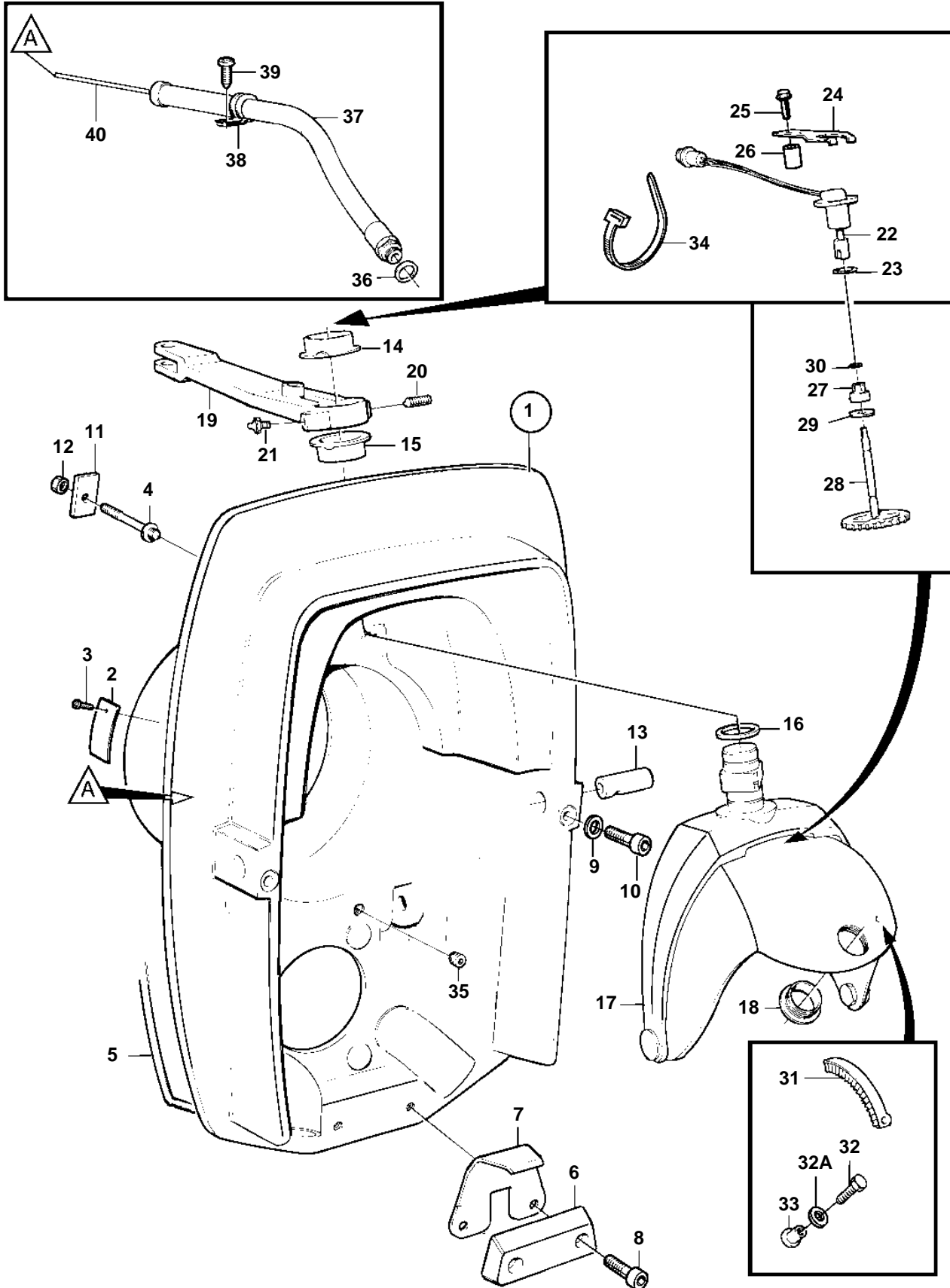

SP-C1, DP-D1

REF	PART NO.	QTY	DESCRIPTION	SEE SEC.	NOTES
1	876630	1	Shield		
2	853706	1	• Type plate		
3	804269	2	• Rivet		
4	873316	6	Stud		
5	852868	X	Sealing strip		L=1750mm
6	852835	1	Zinc electrode		ALT
	873178	1	Magnesium anode		ALT. To be used in fresh-water.
7	872963	1	Support plate		
8	946541	2	Screw		
9	941670	2	Washer		
10	963699	2	Screw		
11	852866	6	Washer		
12	963108	6	Nut		
13	872493	2	Pin		
14	854705	1	Bushing		
15	854704	1	Bushing		
16	977313	1	Sealing ring		
17	872845	1	Steering fork kit		
18	853048	1	• Bushing		
19	872722	1	Spindle arm		
20	947904	1	Set screw		
21	914169	1	Lubricating nipple		
22	873531	1	Potentiometer		
23	955991	1	O-ring		
24	853039	1	Bracket		
25	955298	1	Screw		
26	872355	1	Spacer sleeve		
27	851430	1	Bushing		
28	852984	1	Drive gear		
29	966207	1	Sealing ring		
30	925050	1	O-ring		
31	872812	1	Gear segment		
32	853759	1	Screw		
32A	941907	1	Spring washer		
33	853760	1	Rivet nut		
34	948211	1	Strip clamp		
35	853215	2	Plug		
36	897745	1	Gasket		
37	839091	1	Hose		
38	952635	1	Clamp		
39	955512	1	Screw		
40		1	Control cable	231	